

AUSTIN CD41

High-Power FM/AM/CD Receiver with Detachable Face

Autoradio FM/AM à lecteur CD, de forte puissance et à face amovible

Receptor FM/AM/Reproductor de CD de Alta Potencia y con Panel Extraíble

Rádio FM/AM/CD de Alta Potência com Painel Removível

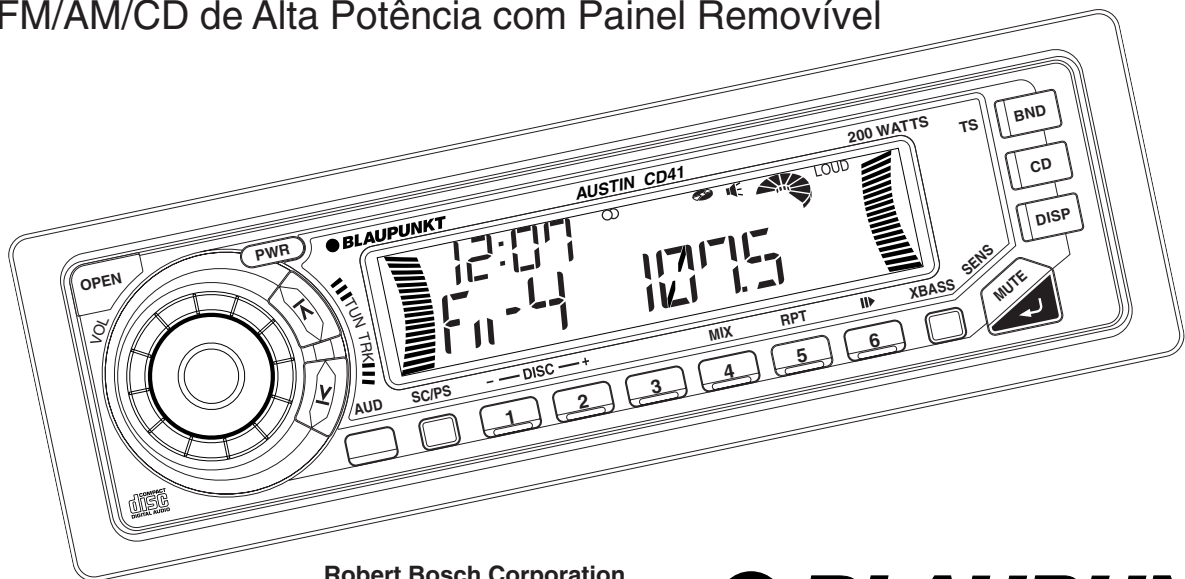

Robert Bosch Corporation
Sales Group —
Blaupunkt Division
2800 South 25th Avenue,
Broadview, Illinois 60155
www.blaupunkt.com

 **BLAUPUNKT**[®]
Bosch Group

FCC WARNING

This equipment has been tested and found to comply with the limits for a Class B device, pursuant to Part 15 of the FCC Rules. These limits are designed to provide reasonable protection against harmful interference in a residential installation. This equipment generates, uses, and can radiate radio frequency energy, and, if not installed and used in accordance with instructions, may cause harmful interference with radio communications. However, there is no guarantee that radio interference will not occur in particular installation. If this equipment does cause harmful interference to radio or television reception, which can be determined by turning the equipment off and on, the user is encouraged to consult the dealer or an experienced radio/TV technician for help.

You are cautioned that any changes or modifications not expressly approved in this manual could void your authority to operate this equipment.

Features

- Detachable Flip Down Front Panel
- Built-in Power Amplifier (max. output : 50W × 4ch)
- 4-ch F & R Preamp Output
- 2-ch Subwoofer Preamp Output
- FM/AM PLL Synthesizer Tuner
- 30 Station Preset Memory
- Travel Store / Scan Tuning
- X-Bass System
- Station Name, Disc Name Store / Station Call
- Auxiliary-input
- Optional IR Remote Control
- CD Changer Control

(IDCA09, CDCA08 & CDCA071*)

* CDCA071 requires adaptor # 7607 898 093 available separately.

Precautions

- Avoid installing the unit where it would be subject to high temperatures, such as in direct sunlight or a hot air stream from the heater, or where it would be subject to dust, dirt, or excessive vibration.
- Do not turn on the unit if the temperature inside the car is very high. Always cool down the unit before usage. Parking your car in direct sunlight will result in a temperature rise.
- If the unit does not turn on, check the connections first. Then check whether the fuse at the back of the unit is blown.
- Carefully read this manual before using the unit. If you encounter any problems that are not covered in this manual, please consult the dealer where you purchased the unit or the dealer nearest to you.
- This unit has been designed specifically for playback of compact discs bearing the  mark. Other discs cannot be played.
- Do not use non-conventional discs such as heart-shaped, octagonal discs, etc. The player could be damaged.

Handling Compact Discs

- Be careful when removing a compact disc after the playback is completed because the disc may be extremely hot.
- Do not use non-conventional discs such as heart-shaped, octagonal discs, etc. The player could be damaged.
- Do not expose compact discs to direct sunlight or any heat source.
- Check all compact discs before playing, and discard cracked, scratched or warped discs.
- Wipe dirty or damp discs outward from the centre with a soft cloth.
- Do not use any solvents such as commercially available cleaners, antistatic spray, or thinner to clean the compact discs.

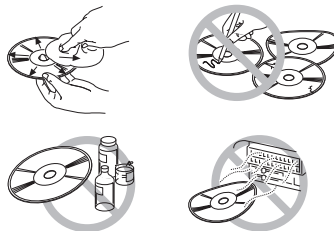

Handling the Front Panel

Attaching the Front Panel

Place the right hand side of the front panel so that the parts ① of the front panel are engaged with the parts ② of the unit as shown below. Then push the left hand side of the front panel until it is securely locked.

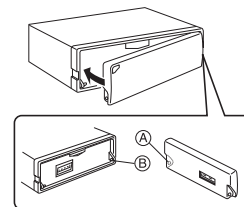

Front Panel Open / Close

Panel open

Press the .

Panel close

Raise the front panel with your finger until it locks in place.

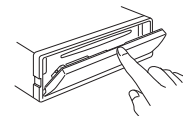
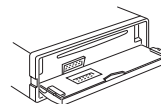

Security / Retailer Display

Bolt the front panel with the locking screw (See page 10) in the inner cover as shown below, to protect the front panel from robbery and from getting lost.

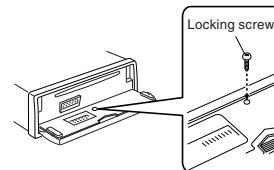

Notes

- Be sure to use this unit with the front panel closed. The unit is automatically switched off when the front panel is left open for about 10 minutes.
- Do not handle the unit roughly when opening/closing the front panel.
- Do not put any object or use it like a tray when the front panel is open in a lying position.
- Do not press OPEN button when closing the front panel.
- Do not put much force to the operation buttons or the display window as it may cause damage or deform the unit.
- Connectors on the unit and front panel are vital parts transmitting the signal. Do not touch, push and scratch them.
- Be careful not to pinch your fingers or hands when opening and closing the front panel.
- Do not press hard on the front panel when affixing it to the unit. No more than light to moderate pressure should be needed.
- Make sure there is no dust or dirt on the electrical terminals on the back of the front panel as this could cause intermittent operation or other malfunctions.
- Clean with alcohol & swabs.

Detaching the Front Panel

1. Press the **OPEN** firmly to open the flip down front panel.



2. Pull the front panel toward your direction to remove it.

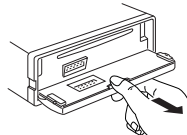

3. Close the inner cover.

Do not leave inner cover in the down position unless the front panel is in place.

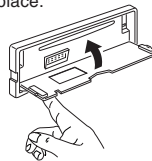

Ejecting the CD

Press the recessed button located to the left behind the Front Panel.

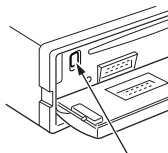

EJECT button

Identification of Controls

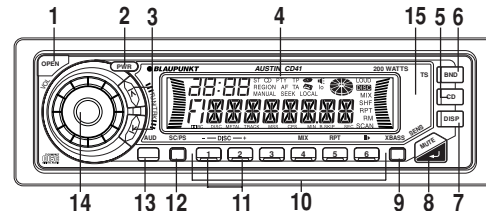

- 1 **OPEN** button
Open the flip down front panel.
- 2 **PWR** button
Turns the power of the unit on or off.
- 3 **TUN/TRK** button
Used to tune in to the desired station.
- 4 **LCD Display window**
- 5 **CD** button
Select the operating source (CD, CD changer or AUX).
- 6 **BND/TS** button
Selects the AM/FM Band & Travel store.
- 7 **DISP** button
Mode selector. Clock adjustment. Display priority setting.
- 8 **MUTE/SENS** button
Muting the sound. Switches the seek sensitivity between local and distance.
- 9 **XBASS** button
Boosting the bass sound.
- 10 **PRESET MEMORY** button
During radio reception :

① - ⑥ ; For Preset memory

During CD mode :

④/MIX ; For Mix play (Mix & Mix all during CDC)

⑤/RPT ; For Repeat play

⑥/⏸ ; For Pause

General Operations

Turning the power On/Off

Press the **(PWR)** to turn on or off the unit.

Tip

When you turn on the unit, "HELLO" will be displayed then "WELCOME" will momentarily be displayed before actual power on.

When you turn off the unit, "SEE YOU" will be displayed then "GOOD-BYE" will momentarily be displayed before actual power off.

You can edit these messages. (See "Turn on/off message edit")

11 DISC SELECT button

Select the desired CD in CDC (CD changer) mode.

12 SC/PS button

Scan tuning. Preset scan tuning. Scan play in CD/CDC mode.

13 AUD button

Audio control selector; Bass, Treble, Loudness, Balance & Fader.

14 Dial

Adjusts the volume level/bass/treble/balance/fader.

Storing the station names. Select alfa-numeric characters.

15 Infrared Sensor (behind acrylic facia)

Permits wireless remote control of AM/FM/CD and CD changer with optional credit card style remote. See Dealer for Details.

Volume Level Control and Memory

Rotate the dial to adjust the volume.

It is also possible to set the maximum volume for when the power is switched on by following the procedure explained below.

1. Turn the dial until it is set at the required volume.



2. Press the **(PWR)** for two or more seconds. The power will be switched off and the current volume level recorded.

Muting the sound

Press **(MUTE / SENS)**.

"MUTE" appears on the display window.

To restore the previous volume level, press **(MUTE / SENS)** again.

Setting the Clock

The clock uses a 12-hour display system. (factory set)

1. Turn the ignition key to the ON position.
2. Press the **(PWR)** to turn on the unit.
3. Repeatedly press the **(DISP)** to display "CLOCK 12".
4. Rotate the dial within 5 seconds to select the 12 or 24-hour time mode. Each time you rotate the dial, the mode changes or toggles as follows :



5. Repeatedly press the **(DISP)** to display "CLK ADJ".

- A. Press the **(MUTE / SENS)** within 5 seconds to flash the hour digit.
- B. Rotate the dial to set the hour digit.
- C. Press the **(MUTE / SENS)** to flash the minute digit.
- D. Rotate the dial to set the minute digit.

6. Press the **(DISP)** momentarily to complete the Clock setting mode.

Note

If you make no button input or dial operation in 20 seconds, the Clock setting mode will turn off automatically.

Ignition-off Clock Recall

The display will illuminate showing the time and then automatically shut off after 5 seconds.

Press the **(DISP)** while the ignition switch is in the "OFF" position.

Mode Selector

Each time the **(DISP)** is pressed, the display window will change over as shown below;

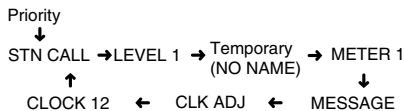

Display priority setting

Display Priority can be set for the following items;

Radio mode

- Frequency and Station Name, plus during

CDC (CD changer) mode

- Disc No, Track No, Track time and Disc name.

Example

To set Station Name to the Display Priority.

1. Press the **(DISP)** three times, and the temporary display appears in the display window.
2. Hold the **(DISP)** pressed for more than 2 seconds. "NO NAME" or a previously assigned station name blinks once to indicate that Station Name is selected for the Display Priority. After 5 seconds, the display mode will automatically return to the Display Priority showing either "NO NAME" or the station name.

Tip

Frequency Display is initially set to the Display Priority, and Station Name ("NO NAME") is set to the "Temporary" indicator.

Adjusting the Sound Characteristics

1. Press the **(AUD)** to select the desired adjustment mode as follows;

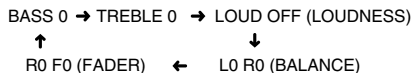

2. Rotate the dial to adjust the selected item.

Adjust within 3 seconds after selecting the item. After 3 seconds, the dial reverts to volume control. Use the following tables as a guide for adjusting the settings in each mode.



Adjustment Range

	Adjustment Range	
BASS	BASS -5	BASS +5
TREBLE	TREBLE -5	TREBLE +5
LOUDNESS	LOUD OFF	LOUD ON
BALANCE	L9 R0(Full left)	L0 R9(Full right)
FADER	R9 F0(Full rear)	R0 F9(Full front)

Tip

Settings for **BASS**, **TREBLE**, **LOUDNESS** and **XBASS** can be made to each of the following modes independently:

FM, AM, CD Changer and AUX.

Switching the Source (Selecting auxiliary input)

You can connect the auxiliary equipment (Portable cassette player, MP3 player, etc.) to this radio via optional AUX-IN cable. (See page 11)

Each time the **(CD)** is pressed, the operation source will change over as shown below;

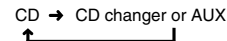

Press the **(BND/TS)** to return to tuner mode.

Note

If the **(CD)** button is pressed when no CD has been loaded into the unit, The CD mode will skip to the CD changer mode or AUX mode.

Also, if the CD changer is not connected, the system will move across to the AUX mode regardless of whether auxiliary equipment is connected or not ("MP3/AUX" will be displayed.) It is not possible to switch to the AUX mode when the CD changer is connected.

Remote Control (Optional)

You can operate your receivers basic AM, FM, CD & CDC features via an optional IR Remote Control. Optional Credit Card type remotes are available. See dealer to order RC823 Credit Card remote.

Radio Reception

Seek Tuning

1. Press the **(BND/TS)** to select the desired AM or FM band.
FM I → FM II → FT → AM (A) → AT
(FT & AT are Travel Store bands.)
2. Press the **(TUN/TRK)** to tune in stations. Tuning automatically stops at a broadcasting frequency.
“SEEK” indicator will appear on the display window.
When tuned in to FM stereo broadcasting stations, the “**Ⓞ**” stereo signal indicator will appear on the display window.

Manual Tuning

1. Press the **(BND/TS)** to select the desired AM or FM band.
2. Press the **(TUN/TRK)** or **(TUN/TRK)** for more than 0.5 second to activate the manual tuning mode. Press again to tune in to stations.
“MANUAL” indicator will appear on the display window.
After 4 seconds of completing Manual Tuning, the tuning control will revert to the Seek Tuning mode.

Scan Tuning

1. Press the **(BND/TS)** to select the desired AM or FM band.
2. Hold the **(SCPS)** pressed for less than 2 seconds.
The unit will scan the selected band for stations.
“SCAN” indicator will appear on the display window. The unit will stop at each station for 8 seconds, before continuing to the next station.
Press the **(SCPS)** again to stop Scan Tuning and remain this on the selected frequency.

Tip

While tuning, the pie-shaped signal-strength meter on the display is lit differently depending on the strength of the signal. While scanning bands, the pie-shaped signal-strength meter spins. While playing CD's, this display spins also.

Preset Scan Tuning

1. Press the **(BND/TS)** to select the desired AM or FM band.
2. Hold the **(SC/PS)** pressed for more than 2 seconds.
“SCAN” indicator will appear on the display window.
The unit will scan preset memory for the 12 stations from the AM/AT band or the 18 stations from the FM I/FM II/FT bands. The unit will stop at each preset station for 8 seconds, before continuing to the next preset station.
Press the **(SCPS)** again to stop Preset Scan Tuning and remain this on the selected frequency.

Memorizing Stations Automatically (Travel Store)

1. Press the **(BND/TS)** to select the desired AM or FM band.
2. Hold the **(BND/TS)** pressed for longer than 2 seconds.
Up to 6 stations with strong signals will be automatically stored in preset memory for the selected band.
If the radio is in FM I or FM II, it switches to FT. If the radio is in AM, it switches to AT.

Note

This function is available for FT and AT.

Memorizing Only the Desired Stations

You can store up to 6 stations on each band (18 for FM I, FM II and FT, 12 for AM and AT) in the order of your choice.

1. Press the **(BND/TS)** to select the desired band.
2. Press the **(TUN/TRK)** to tune in stations.
3. Press and hold the desired preset memory button **(1)** - **(6)** for about 2 seconds until the frequency indicator flashes twice.
The number of the pressed preset memory button appears on the display window.

Note

If when you store another station on the same preset number button, the previously stored station is replaced with new one.

Receiving the Memorized Stations

1. Press the **(BND/TS)** to select the desired AM or FM band.
2. Press the **(1)** → **(6)** momentarily.

Local/Distant (LO/DX) Selection

This feature is used to select the signal strength at which the radio will stop during Seek Tuning.

Press the **(MUTE/SENS)** for more than 2 seconds to select the Local setting and only strong (local) stations will be received. The “lo” indicator appears on the display window.
Pressing for more than 2 seconds again will select the Distant setting and the radio will stop at a wider range of signals, including weaker more distant stations. The “lo” indicator will go out on the display window. DX is the suggested default setting.

Storing the station names

You can assign a name to each radio station and store it in memory. As many as 30 station names can be stored composed with 8 characters each.

Storing the station names

1. Tune in a station whose name you want to store.
2. Press the **(DISP)** for more than 2 seconds.
The "NAME EDT" will light then the " _ _ _ _ _ _ _ _ " on the display window. The first " _ " flashes.
3. Enter the characters.
 - A. Rotate the dial in a clockwise direction to select the desired characters.
(A → B → C → . . . Z → < → > → * → + → , → - → ' → / → 0 → 1 → 2 → 3 . . . 9 → " "Space)
 - B. Press the **(TUN/TRK ▲)** to move the flashing cursor to the next position. If you press **(▼ TUN/TRK)**, the flashing cursor moves to the left.
 - C. Repeat steps A. and B. to complete entering the entire name 8 characters max.

Tip

To erase/correct a name, press the **(DISP)** for more than 2 seconds to clear the character and re-enter.

4. Press the **(MUTE / SENS)** to store the station name.
The station name flashes.
5. To return to the normal radio reception, Press **(DISP)**.

Erasing the station names

1. Tune in any station and press the **(DISP)** for more than 2 seconds.
2. Press the **(MUTE / SENS)**.
The station name or " _ _ _ _ _ _ _ _ " flashing.
3. Rotate the dial to select the name of the station that you want to erase. To erase all the names of the stations, display " *ALL DEL ".
Repeat steps 3. and 4. if you want to erase other names.
4. Press the **(DISP)** for more than 2 seconds.
5. To return to the normal radio reception, Press **(DISP)**.

Direct Access to Memorized Stations via Station call

You can search for the memorized AM & FM station names in the memory.

1. Press the **(DISP)** to display the " STN CALL " on the display window.
2. Rotate the large dial to select the desired station name.
3. Press the **(MUTE / SENS)** to tune in the desired station.

Level Meter selection

The meter displays can be selected from four types.

You can select :

- METER 1 : The level meter goes upward.
- METER 2 : Only the very top segment lights.
- METER 3 : The remaining segments light. (opposite of METER 2)
- METER 4 : The level meter goes up and down dividing from the center segment.
- METER 0 : No meter is indicated.

1. Press the **(DISP)** to display the " METER 1 " on the display window.
2. Rotate the dial in a clockwise direction to select the desired meter indication.

METER 1 → METER 2 → METER 3 → METER 4 → METER 0

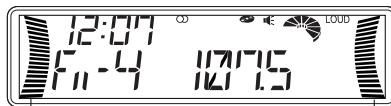

L-ch Level meter

R-ch Level meter

Level Meter Sensitivity selection

The sensitivity of the level meter display can be switched.

You can select :

- LEVEL 1 : Normal sensitivity.
- LEVEL 2 : High sensitivity.

1. Press the **(DISP)** to display the " LEVEL 1 " on the display window.
2. Rotate the dial to select the desired meter sensitivity.



Enhancing the bass sound

For extended bass centered @ 72Hz, Blaupunkt's X-Bass function can be set for either each band and CD mode.

You can select :

- X-Bass 1 : Enhanced BASS level (low).
- X-Bass 2 : Enhanced BASS level (Middle).
- X-Bass 3 : Enhanced BASS level (High).
- X-Bass 4 : Enhanced BASS level (Very high).
- X-Bass 0 : No BASS enhanced.

Press the **(XBASS)** repeatedly to select the bass sound.

" X " appears on the display window.

Each time you press **(XBASS)**, the current mode appears on the display window and the mode change as follows:

XBASS 0 → XBASS 1 → XBASS 2 → XBASS 3 → XBASS 4

Note

Reduce XBASS levels if your combination of speakers and add-on amplifiers sound distorted at the preferred sound level.

Turn on/off message edit

You can edit the turn on/off message and store it in memory. Following four messages (factory set) can be edit with 8 characters each.

Turn-on message

- MESSAGE 1 : HELLO
- MESSAGE 2 : WELCOME

Turn-off message

- MESSAGE 3 : SEE YOU
- MESSAGE 4 : GOOD-BYE

1. Repeatedly press the **[DISP]** to display the "MESSAGE" on the display window.
2. Rotate the dial to select the desired message you want to edit.

MESSAGE1 → MESSAGE2 → MESSAGE3 → MESSAGE4

3. Press the **[MUTE/SENS]**, then enter the character.
 - A. Rotate the dial in a clockwise direction to select the desired characters.
(A → B → C → ... Z → < → > → * → + → , → - → ' → / → 0 → 1 → 2 → 3... 9 → " "Space)
 - B. Press the **[TUN/TRK ▲]** to move the flashing cursor to the next position. If you press **[TUN/TRK ▼]**, the flashing cursor moves to the left.
 - C. Repeat steps A. and B. to complete entering the entire message 8 characters max.

Tip

To erase/correct a message, press the **[DISP]** for more than 2 seconds to clear the character and re-enter.

4. Press the **[MUTE/SENS]** to store the message.
The new message flashes.
5. To return to the normal radio reception, Press **[DISP]**.

Note

If you make no button input or dial operation in 20 seconds, the message edit mode will turn off automatically.

Erasing the turn on/off message

You can erase the turn on/off message if so desired.

1. Repeatedly press the **[DISP]** to display the MESSAGE, then rotate the dial to select the message you want to erase.
2. Press the **[MUTE/SENS]**.
The message flashing.
3. Press the **[DISP]** for more than 2 seconds.
Repeat steps 1. and 3. if you want to erase other message.
4. To return to the normal radio reception, Press **[DISP]**.

Demonstration mode

The unit shows a demonstration of each function. When a demonstration is finished, it begins again after 10 seconds, and this is repeated.

1. Press the **[PWR]** to turn off the unit.
2. Press the **[DISP]** and **[1]** simultaneously for more than 2 seconds to activate the demonstration mode.
Press both button again for more than 2 seconds to cancel this mode.

Playing the CD player

Loading Discs

1. Press the **[OPEN]** and insert the disc.
2. Close the front panel.
Playback begins automatically.
"LOADING" indicator will flash in the display window.

Note

Make sure that the front panel is closed when playback begins.

Playback with the front panel open causes the unit to turn off automatically in about 10 minutes.

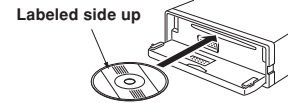

! NEVER Insert a 3-inch CDs.

This unit is designed for playback of standard 5-inch CD's only. Do not attempt to use 3-inch CD singles in this unit, either with or without an adaptor, as damage to the player and/or disc may occur.

Tips

- When a CD is loaded, the **[PWR]** on the display remains lit.
- During playback of a CD, the pie-shaped signal-strength meter **[SIGNAL]** spins.

Listening to a disc that is already loaded

Press the **CD** to select the CD mode. Playback begins automatically.

Pausing Playback

Press the **⏸**. To resume playback, press the **▶** again.

Stopping Playback

Press the **BND/TS** to select the radio reception (FM I, FM II, FT or AM, AT).

Ejecting Discs

Press the **⏏** to eject the disc located behind flip-down front panel.

Notes

- *The unit will turn on automatically when a CD is inserted if the ignition switch is "ON".*
- *When the disc is ejected from the CD slot, remove it within 10 seconds; otherwise, the disc will be reloaded automatically.*

Track Search

Press the **TUN/TRK** during CD mode. Track numbers appear in the display window.

- ⏪** : Playback starts from the beginning of the next track.
- ⏩** : Playback starts from the beginning of the current track. Press again to play the previous track.

Cue / Review

Press and hold the **TUN/TRK**. Release when you have found the desired point.

- ⏪** : To search forward.
- ⏩** : To search backward.

Scan Play

Press the **SCPS** during CD mode. The "SCAN ON" indicator appears in the display window. This will play the first 10 seconds of all the tracks on the disc. Press the **SCPS** again to cancel this feature.

Repeat Play

Press the **SIRPT** during CD mode. The "RPT ON" indicator appears in the display window and the current track is played repeatedly. Press the **SIRPT** again to cancel this feature.

Mix Play

Press the **4/MIX** during CD mode. The "MIX ON" indicator appears in the display window. All the tracks on the current disc are played in random order. Press the **4/MIX** again to cancel this feature.

Playing the CD Changer

This product can control a Blaupunkt CD changer. Please check with your nearest car stereo specialist for recommendations of the models that will work with this radio (See page 1).

Press the **CD** to switch the CD changer mode. Disc No, Track No, and Track time appear on the display window and playback begins automatically. Press again to change back to built-in CD operation.

Disc Select

Press the Disc select buttons to select the desired disc for play.

- +72** : To advance to a higher number disc.
- 11** : To return to a lower number disc.

Track Search

Press the **TUN/TRK**. Track numbers appear in the display window.

- ⏪** : Playback starts from the beginning of the next track.
- ⏩** : Playback starts from the beginning of the current track. Press again to play the previous track.

Cue / Review

Press and hold the **TUN/TRK**. Release when you have found the desired point.

- ⏪** : To search forward.
- ⏩** : To search backward.

Track / Disc Scan Play

Track Scan

Press the **SCPS**. The "SCAN ON" indicator appears in the display window. This will play the first 10 seconds of all the tracks on the disc. Press the **SCPS** again to cancel this feature.

Disc Scan

Press the **(SC/PS)** for more than 2 seconds.

The “ DSCAN ON ” indicator appears in the display window. This will play the first 10 seconds of the first track on each disc. Press the **(SC/PS)** again to cancel this feature.

Track / Disc Repeat Play**Track Repeat**

Press the **(S/RPT)**.

The “ RPT ON ” indicator appears in the display window and the current track is played repeatedly.

Press the **(S/RPT)** again to cancel this feature.

Disc Repeat

Press the **(S/RPT)** for more than 2 seconds.

The “ DRPT ON ” indicator appears in the display window and the current disc will be continually repeated.

Press the **(S/RPT)** again to cancel this feature.

Track / Disc Mix Play**Track Mix**

Press the **(4/MIX)**.

The “ MIX ON ” indicator appears in the display window.

All the tracks on the current disc are played in random order.

Press the **(4/MIX)** again to cancel this feature.

Disc Mix

Press the **(4/MIX)** for more than 2 seconds.

The “ DMIX ON ” indicator appears in the display window.

Both discs and tracks will be played in random order.

Press the **(4/MIX)** again to cancel this feature.

Tip

During Disc scan, Disc Repeat or Disc Mix, the **DISC** will be lit on the display.

Storing the CDC disc names

You can label each disc with a personalized name. As many as 99 disc names can be stored, composed with 7 characters each.

Storing the CDC disc names

1. Play the CD and press the **(DISP)** for more than 2 seconds. The “ NAME EDT ” will light then the “ _ _ _ _ _ ” on the display window. The first “ _ ” flashes.
2. Enter the characters.
 - A. Rotate the dial in a clockwise direction to select the desired characters.
(A → B → C → . . . Z → < → > → * → + → , → - → ' → / → 0 → 1 → 2 → 3 . . . 9 → ” Space)
 - B. Press the **(TUN/TRK ▲)** to move the flashing cursor to the next position. If you press **(TUN/TRK ▼)**, the flashing cursor moves to the left.
 - C. Repeat steps A. and B. to complete entering the entire name 7 characters max.

Tip

To erase/correct a name, press the **(DISP)** for more than 2 seconds to clear the character and re-enter.

3. Press the **(MUTE / SENS)** to store the disc name. The disc name flashes.
4. To return to the normal CD playback mode, Press **(DISP)**.

Erasing the CDC disc names

1. Press the **(DISP)** for more than 2 seconds during CD changer mode.
2. Press the **(MUTE / SENS)**. The disc name or “ _ _ _ _ _ ” is now flashing.
3. Rotate the dial to select the name that you want to erase. To erase all the name, display “ *ALL DEL ”.
4. Press the **(DISP)** for more than 2 seconds. Repeat steps 3. and 4. if you want to erase other names.
5. To return to the normal CD playback mode, Press **(DISP)**.

Direct Access to Memorized Disc Names via Disc call

You can search for the memorized disc names in the memory.

1. Press the **(DISP)** to display the “ DSC CALL ” on the display window.
2. Rotate the large dial to select the desired disc name.
3. Press the **(MUTE / SENS)** to start playback for the desired disc.

Installations

ENGLISH

Supplied Mounting Hardware

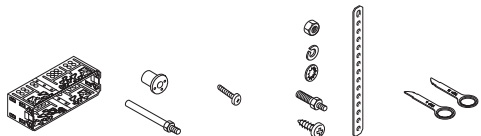

Sleeve Bushing, Locking screw Mounting Strap and Screw Release Keys

Precautions

- Be sure to detach the front panel before you start installing the unit.
- Choose the mounting location carefully so that the unit will not interfere with the normal driving operations of the driver.
- Use only the supplied mounting hardware for a safe and secure installation.
- When mounting the unit in a car, keep the unit as level as possible. If the unit must be mounted at an angle, due to the design of the vehicle, make sure that the unit does not tilt upward by more than 30°.

Mounting Example

Installation in the dashboard.

1. Install the sleeve in the dashboard.

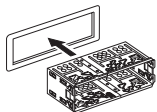

2. Select and bend the appropriate tabs to hold the sleeve firmly in place.



Mounting Strap Use*

3. Attaching the Mounting Strap to the underside of the dash board, using screw.
Attach the back of the unit to the Mounting Strap using the support stem bolt and hardware.

Bushing Use

3. As shown in the figure below, securely fasten the screw, which has been inserted into the bushing to the rear of the set.

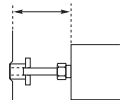
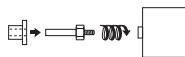
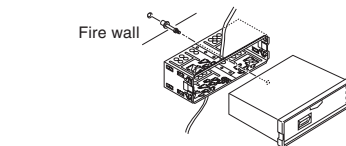

The distance to the fire wall varies due to the type of the car. Be sure to secure the unit by properly inserting the bushing.

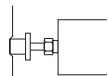

*Caution

Insufficient fastening of the screw or mounting strap may cause some CD's to skip.

If your car has no accessory position on the ignition key switch (POWER SELECT switch)

The illumination on the front panel is factory-set to be turned on even when the unit is not being played. However, this setting may cause some car battery wear if your car has no accessory position on the ignition key switch. To avoid this battery wear, set the POWER SELECT switch located on the bottom of the unit to the (B) position, then press the RESET button. The illumination is reset to stay off while the unit is not being played.

Reset button
Press the reset button with the point of a sharp object such as a ball-point pen.

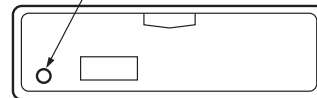

POWER SELECT SWITCH (Located on the bottom of the unit)

Change the position with a jeweler's screwdriver, etc.

- (A) : Your car has an accessory position on the ignition switch.
- (B) : Your car has no accessory position on the ignition switch.

Be sure to press the reset button after changing the switch and connecting the lines.

Connections

Warning

- To prevent short circuit, remove the key from the ignition and disconnect the battery's (-) terminal.
- This unit is designed for negative ground 12 VDC operation only. You can not use it for 24 V or other types of car batteries.

Connection procedure

Caution

- DO NOT connect any speaker wires to the metal body or chassis of the vehicle.
- DO NOT connect the speaker common (-) wires to each other.
- Connect each speaker wire directly to each speaker terminal.
- All speaker common (-) wires must remain floating. ie. No common connections or connection to vehicle grd.
- Connect each pair of speaker leads only to a single speaker (or speaker system) that has an impedance of least 4 ohms, as well as 50-watt power-handling capability.
- Do not connect speaker leads to any inputs on external amplifiers. This will cause damage to the internal amplifier of this unit.

- 1 Make sure the car's ignition key has been removed.
- 2 Disconnect the negative(-) terminal of the car's battery.
- 3 Connect the wiring harness wires in the following order : Ground wire (Black), +12V Constant Power Supply (Yellow), +12V Accessory/Switched (Red) and Power Antenna/Amplifier Turn On (Blue), and tape each so they do not come in contact with each other.
- 4 Connect the speaker wires of the wiring harness.
- 5 Connect the car's antenna terminal to the antenna socket of the unit.
- 6 Connect the detachable wire harness to the unit.
- 7 Reconnect the negative(-) terminal of the car's battery.
- 8 Start the car's engine.
- 9 Make sure the unit operates properly.

Connection procedure

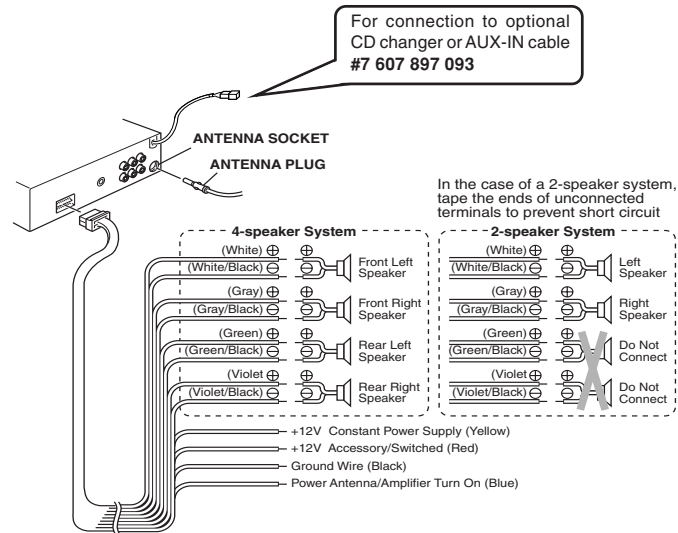

Preamp Out/Line Out Connections

- Since this unit has Line Level Outputs, you can use an amplifier to upgrade your vehicle stereo system.

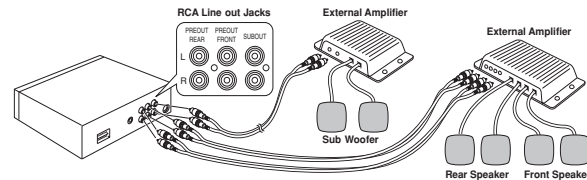

RCA Line-out Jacks

- Connect a patch cable (not supplied) from the White and Red RCA line output jacks of the unit to the line input terminals of the external amplifier.

Handling the Remote Control Unit

ENGLISH

Removing the battery insulation sheet

If an insulation sheet is attached to the remote control unit, make sure to remove the insulation sheet before use. In this case, the batteries will already be inside and can be used immediately.

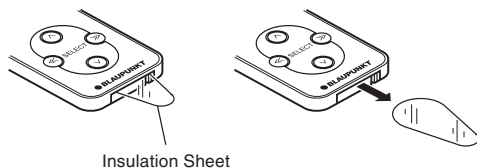

Insulation Sheet

Inserting Batteries

1. Push A in the direction of the arrow while holding B and pull out.
2. Confirm that the (+) (-) terminals are correctly aligned and insert the lithium battery (CR2025).
3. Push in the battery case until a "click" can be heard.

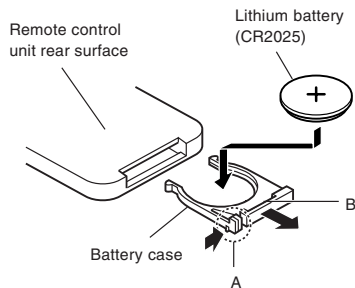

Operation

Operate while facing towards the sensor of the main unit.

Switching the Source ^{LIST SRC}

The mode will switch each time the SRC button is pressed.

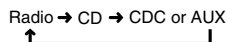

Direct Access ^{LIST SRC}

For direct access during radio mode or CDC mode, use the following operations.

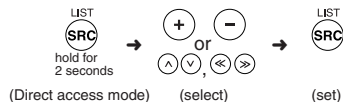

	Radio mode	CD mode	CDC mode	Aux
^{LIST SRC} SRC	Seek tuning Preset scan**	Scan play	Scan play Disc scan**	—
(+) (-)	Volume up/down			
(^)	Seek tuning	cue*	Disc up	—
(v)		Review*	Disc down	
(>)	Preset select	Track search	Track search	—
(<<)	Band select Treble store**		Cue/Review*	

* Press and hold

** Press and hold for 2 seconds

Precautions on battery use

Always use lithium batteries (CR2025).

Warning

Use the lithium batteries properly

- (1) Never recharge, short circuit, disassemble, modify, heat or place in fire. This may result in fire, generation of heat or explosion.
- (2) Place batteries out of reach of infants. If accidentally swallowed, consult a physician immediately.
- (3) Use tape to insulate whenever disposing or storing batteries. Contact with metals or other batteries may result in fire or explosion.

Caution

- Properly align the battery (+) (-) terminals
- Improper handling of batteries may cause fluid leakage or explosions and may result in damage to the device or injury.
- Align the battery (+) (-) terminals correctly.
- Do not leave the remote control unit in high temperature such as from direct sunlight. It results in the deformation of the case, leakage of battery acid, and so on.

Maintenance

Replacing the Fuse

If the fuse is blown, check the power connection first and then replace the fuse. If the fuse blows again under normal conditions, the unit may be defective.

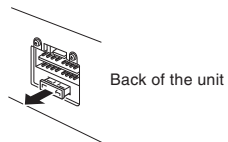

Warning

*Use only a fuse with the specified amperage (10 A).
Use of another type of fuse can result in a fire or unit damage.*

Cleaning the Connectors

If the connectors of the unit and the front panel are contaminated, malfunctions may occur. Detach the front panel and clean the connectors with an alcohol dampened cotton swab as shown below.

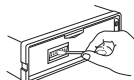

Main unit

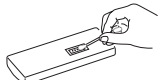

Back of the front panel

Returning to the Initial Settings

When the reset button is pressed, the microcomputer of the unit returns to the initial settings. If the display window is not properly shown or the unit malfunctions, press the reset button with the point of a sharp object such as a ball-point pen.

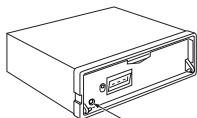

Reset button

Removing the Unit

Use the supplied release keys when you need to remove the unit from the car.

Insert the "TOP R" and "TOP L" of the release keys on the right and left position until it clicks respectively, to remove the unit.

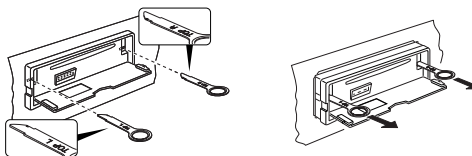

As shown in the figure below, push the plate spring firmly to remove the release keys.

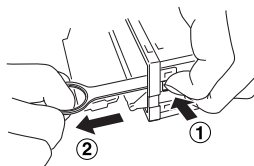

Notes

- Handle the release keys carefully to avoid injuring your fingers.
- Keep the release keys in a safe place for future use.

Troubleshooting Guide

Specifications

The following check will assist in the correction of most problems which you may encounter with your unit. Before going through the check list below, refer back to the connection and operating procedures.

General

Trouble	Cause/Solution
<ul style="list-style-type: none"> Memorized stations and correct time are erased. The fuse has blown. Radio works when the ignition key is the ON, ACC and OFF positions. 	Leads are not matched correctly with the car's accessory power connector. Check wiring for short circuits.
<ul style="list-style-type: none"> No power is being supplied to the unit. The power is continuously supplied to the unit. 	The car doesn't have an ACC position.

Radio reception

Trouble	Cause/Solution
Preset stations are not receivable.	The broadcast signal is too weak.
Seek tuning is not possible	The broadcast signal is too weak. → Use manual tuning.
Travel Store feature does not complete storing of six stations.	Not enough broadcast frequencies are receivable.

Also make sure that antenna is connected, extended and dry inside.

If the above mentioned solutions do not help to improve the situation, consult your nearest **Blaupunkt** dealer or in the United States call 1-800-266-2528 for technical assistance, parts and service. Call 1-800-950-2528 for dealer referral or to request product brochure.

CD Player Troubleshooting

When problems occur with CD playback, an error message appears in the display window.

Refer to the table below to identify the problem, then take the suggested corrective action. If the "MECA ERR" appears or "SW ERROR" persists, contact your nearest **Blaupunkt** dealer.

Message	Possible cause	Recommended action
CD ERROR	Dirty disc.	Clean the disc.
	Scratched disc.	Replace the disc.
	Up-side-down.	Check the disc.
	Focus error.	Try ejecting and re-inserting under normal temperature conditions.
	Data and focus error.	Under normal temperature conditions, eject and insert clean, undamaged disc properly.

SW ERROR Mechanical problem. Eject and re-insert.

CD Changer Troubleshooting

When problems should develop while operating CD changer, an error message appears in the display window.

Refer to the table below to identify the problem, then take the suggested corrective action. If the error persists or "09 ER-ROR" appears, contact your nearest **Blaupunkt** dealer.

Message	Possible cause	Recommended action
NO DISC	No magazine. No disc. Up-side-down.	Load the magazine in the CD changer. Check the disc.
01 ERROR	CD-ROM is loaded.	Replace with Music CD's.
COM ERR	Communication error.	Check the connection of the CD changer.
TEMP ERR	Excessive temperature conditions at the CD changer.	The error sign will go off and play will resume the when the temperature to a normal range.

GENERAL

Dimensions	: Approx. 178 mm × 50 mm × 155 mm (W × H × D)
Power requirements	: 12 volts DC car battery (negative ground)
Output Power	: 50 watts × 4 channels
Output Wiring	: Floating-ground type designed for 4 speaker use. RCA low-level outputs (4 channels).
Output Impedance	: Compatible with 4-8 ohm speakers.
Low - Level Output F/R & Sub Output	: 3 V

TUNER

Tuning Range	: AM : 530 - 1,710 kHz (10 kHz step) FM : 87.5 - 107.9 MHz (200 kHz step)
Sensitivity	: AM : 20 μV FM : 9.1 dBf mono sensitivity
FM Stereo Separation	: 40 dB

CD Player

Frequency Response	: 20 - 20,000 Hz
S/N Ratio	: 98 dB
Wow & Flutter	: Below the measurable limit
Remote Control options	: RC-823 Credit Card Remote